

REVISIONS				
ZONE	REV.	DESCRIPTIONS	DATE	APP.

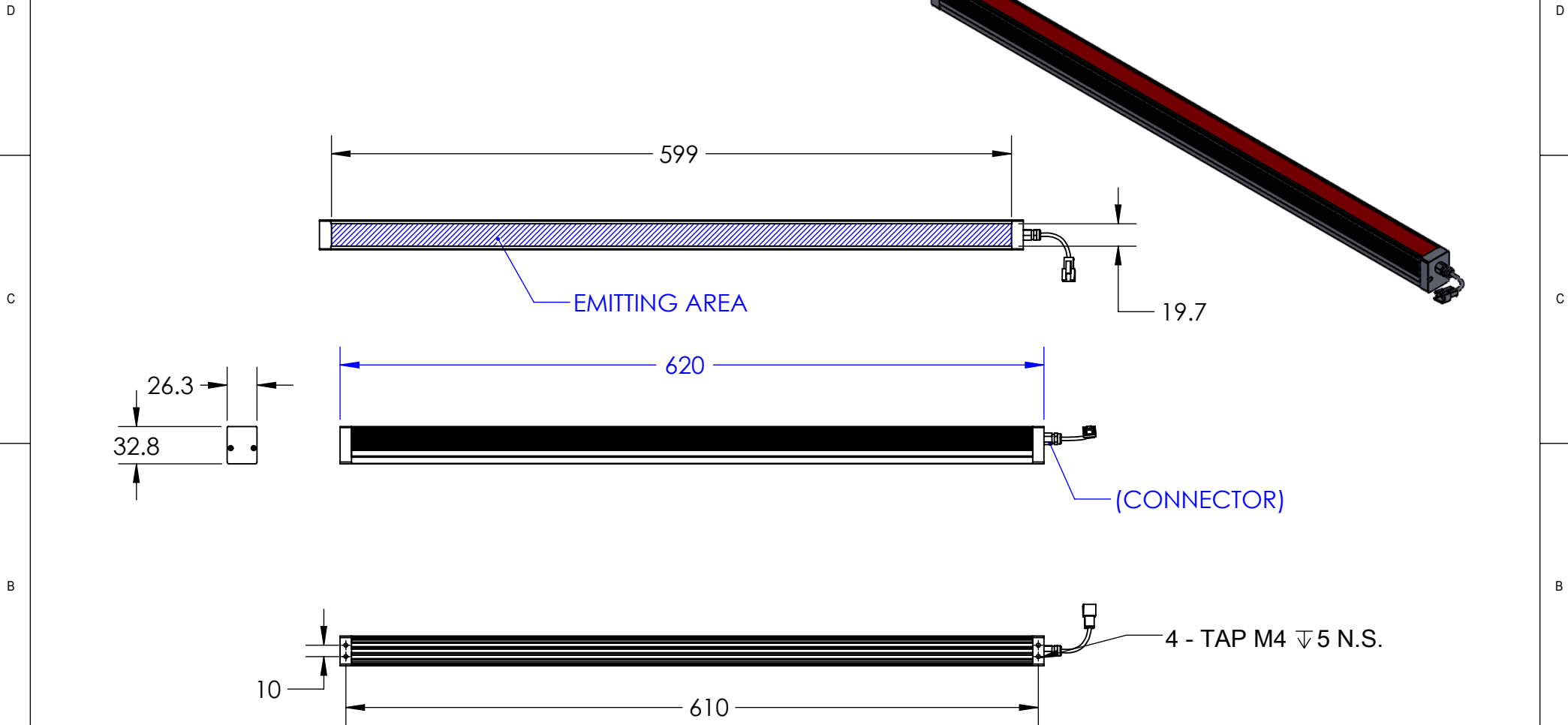

DESIGN BY	MY LAI	UNIT:	PRODUCT SERIES: BLK SERIES		
CHECK BY	KB TAN	MM			
DATE	13/01/2016	REVISION:	TITLE	DRAWING LAYOUT	COLOUR: - -
MATERIAL	-	01	PART NO	BKL-600-X	VOLTAGE: - -
FINISHING	-	SCALE:	DWG NO	-	CURRENT: - -
QTY	-	1:5			POWER: - -
					SHEET 1 OF 1